



5130 Riverside Drive • Chino, CA 91710 • 909.628.1201 • www.chino.k12.ca.us

BOARD OF EDUCATION: Andrew Cruz • Christina Gagnier • Irene Hernandez-Blair • James Na • Joe Schaffer • SUPERINTENDENT: Norm Enfield, Ed.D.

May 13, 2020

BID # /PROJECT: 19-20-46F / Don Lugo HS & Chino Hills HS Re-Roofing
SUBJECT: Addendum #2 (revised)

The following changes, omissions, and or additions to the Project Manual and/or Drawings shall apply to proposals made for and to the execution of the various parts of the work affected thereby, and all other conditions shall remain the same.

Careful note of the addendum shall be taken by all parties of interest so that the proper allowances may be made in strict accordance with the Addendum, and that all contractors shall be fully advised in the performance of the work which will be required of them.

Bidder shall acknowledge receipt of this Addendum in the Space provided on the Bid Form. Failure to do so may subject Bidder to be disqualified.

In case of conflict, this Addendum shall govern.

Campus Maps – Chino Hills High School – Campus Map with Building Letters

END OF ADDENDUM #2 (revised)

Attachments: Plans (3 files)

Respectfully submitted,

Anna G. Hamilton
Purchasing Director

CHINO HILLS HIGH SCHOOL

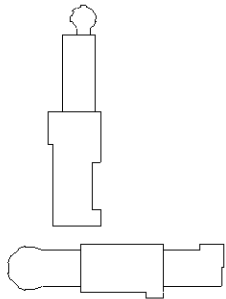
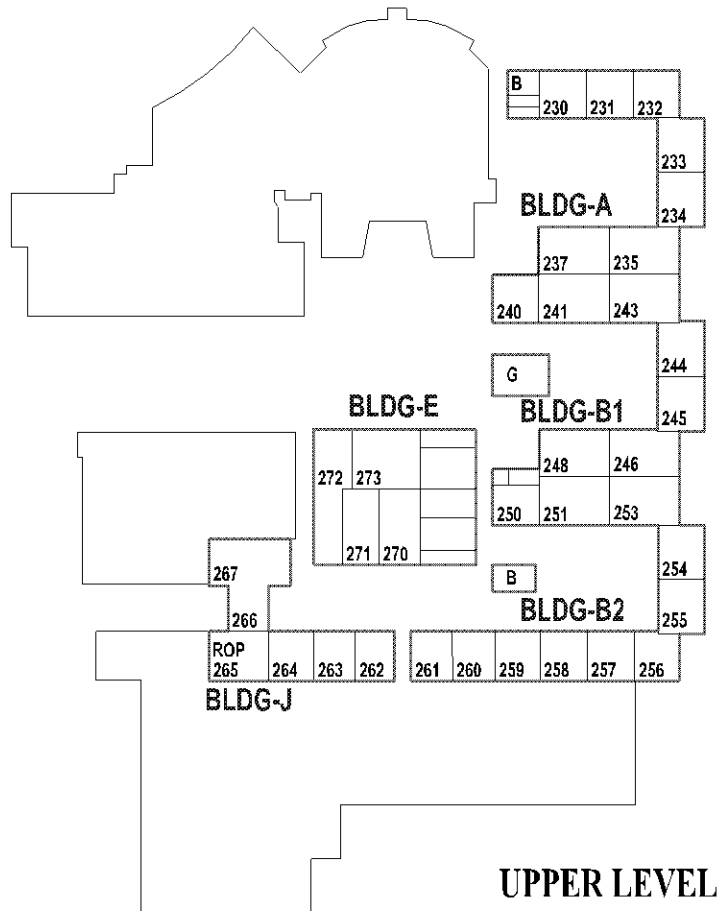
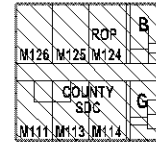
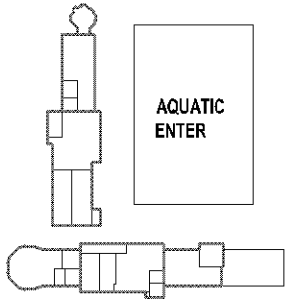
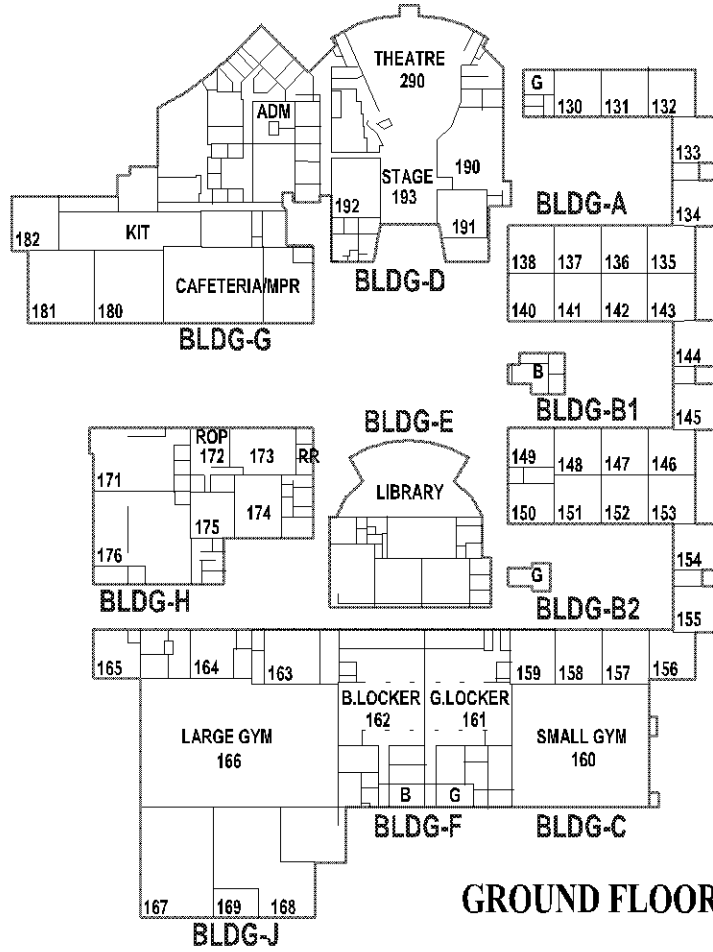

ST. GAUDENS ROAD

POMONA RINCON ROAD

NOTE

① APPROX. LOCATION OF FIRE SPRINKLER RISER, W/ TAMPER SWITCH & FLOW SWITCH & CONTROL VALVE.

② APPROX. LOCATION OF STANDPIPE

POOL HEATER - 1" G.C. & CAP (800 CFH)

CONNECT 1/2" MPG TO 1/2" MPG

4" W BEL. GRD FOR CONT. SEE SHT. BP-1R

CONNECT 4" MPG TO 4" MPG

MANHOLE PER CITY OF CHINO HILLS REQUIREMENTS

FOR CONT. SEE CIVIL DWG.

NEW M.H. (SEE CIVIL DWG.)

EXIST. 21" SEWER

EXIST. 36" SEWER

EXIST. 12" SEWER

ADDENDUM NO. 4

ENLARGED SITE PLAN - WATER, GAS AND SANITARY SEWER

SCALE: 1" = 40'-0"

1

CARROLL KEMP ARCHITECTS A.I.A.

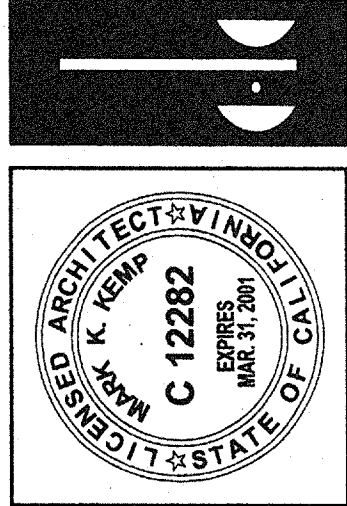

REGISTRATION STAMP
DIV. OF THE STATE ARCHITECT
OFFICE OF REGULATION SERVICES

APPL. _____
AC. _____
FLS. _____
SS. _____
DATE _____

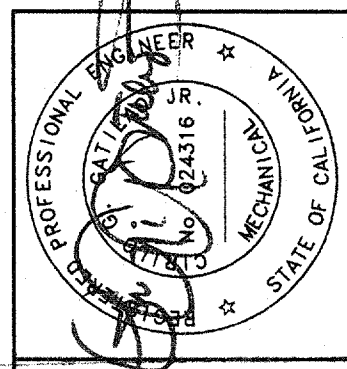

CEEG Consultants
CALIFORNIA ENGINEERING DESIGN GROUP, INC.
2725 West Burbank Blvd.
BURBANK, CA 91505
(818) 566-7755

ENLARGED SITE PLAN - WATER GAS & SANITARY SEWER
HIGH SCHOOL #4
POMONA RINCON ROAD & PICASSO DRIVE, CHINO HILLS, CA
CHINO VALLEY UNIFIED SCHOOL DISTRICT CHINO, CA

JOB NO. 8807-1
DATE: _____
SHEET NUMBER
P-102AR
BINDING ORDER
CEEG No. 5848

Barn
BLDG-Q

Green House

RR

307
306

305
304

300
303
301
302
BLDG-K

212
211

209 208 207 206
205 204 203 202 201
BLDG-L

210
NURSE
BLDG-L

CC1

ADM
BLDG-B

BLDG-E

WT. ROOM
SPIRIT RM

GLOCKER
BLDG-G

POOL

49 50 51 52 53 54 55 56 57 58 59 60
61 63 62 64 65 66 67 68 69 70 71 72 73 74 75 76
LIB
COMP
BLDG-C

BLDG-F
B.LOCKER
GYM
91 90
RR

MPR
123 124 121 122
BLDG-N
KIT
BLDG-D

Shade Structure

100 101 103
BLDG-V

102 105
104 107
106 109
108 111
BLDG-U

110 113
112 115
114 117
116 119
BLDG-T

38 27 18 19 10 9
36 28 16 17 8 7
34 26 15 15 6 5
32 24 13 13 4 3
30 22 11 11 2 1
BLDG-A
COMP

DON LUIGO HIGH SCHOOL